

Knastskiveomskiftere og afbrydere



Telux



MTO
electric a/s

	Nom. strøm term.	Front skilt	Front mont.	Enkelt huls mont. Ø22,5	Bund mont.	Plastik hus	Horisontal hus	Trykstøbt silumin hus
	I _{th}	Kvadratisk						
			IP40 M10-M20: IP65	IP65	IP40	..P.. IP40 ..PF.. IP65	IP65	..G.. IP40 ..GF.. IP65
Type	A	mm						
M10H	20	48	M10H E	M10H Z	M10H V			
M10	20					M10 P(F)		
M20	32		M20 E	M20 Z	M20 V			
N20	32	64	N20 E		N20 V	N20 P(F)		N20G(F)
N33F	50		N33F E		N33F V	N33 FP(F)		M33FG(F)
N40	63	88	N40 E		N40 V	N40 P(F)	N40 PLF	
N60	85		N60 E		N60 V	N60 P(F)	N60 PLF	
N80	115		N80 E		N80 V	N80 P(F)	N80 PLF	
N100	150	132	N100 E		N100 V	N100 P(F)		
N200	250		N200 E		N200 V	N200 P(F)		

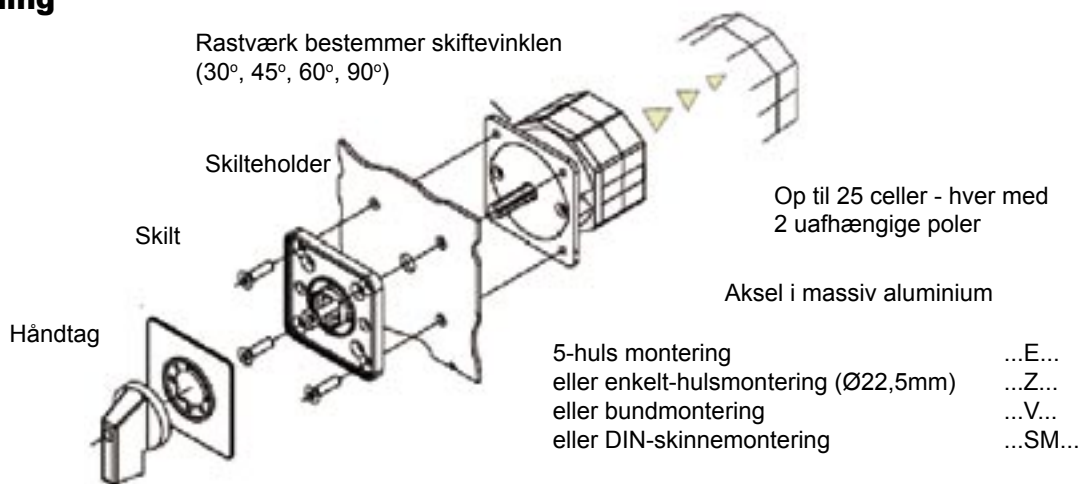
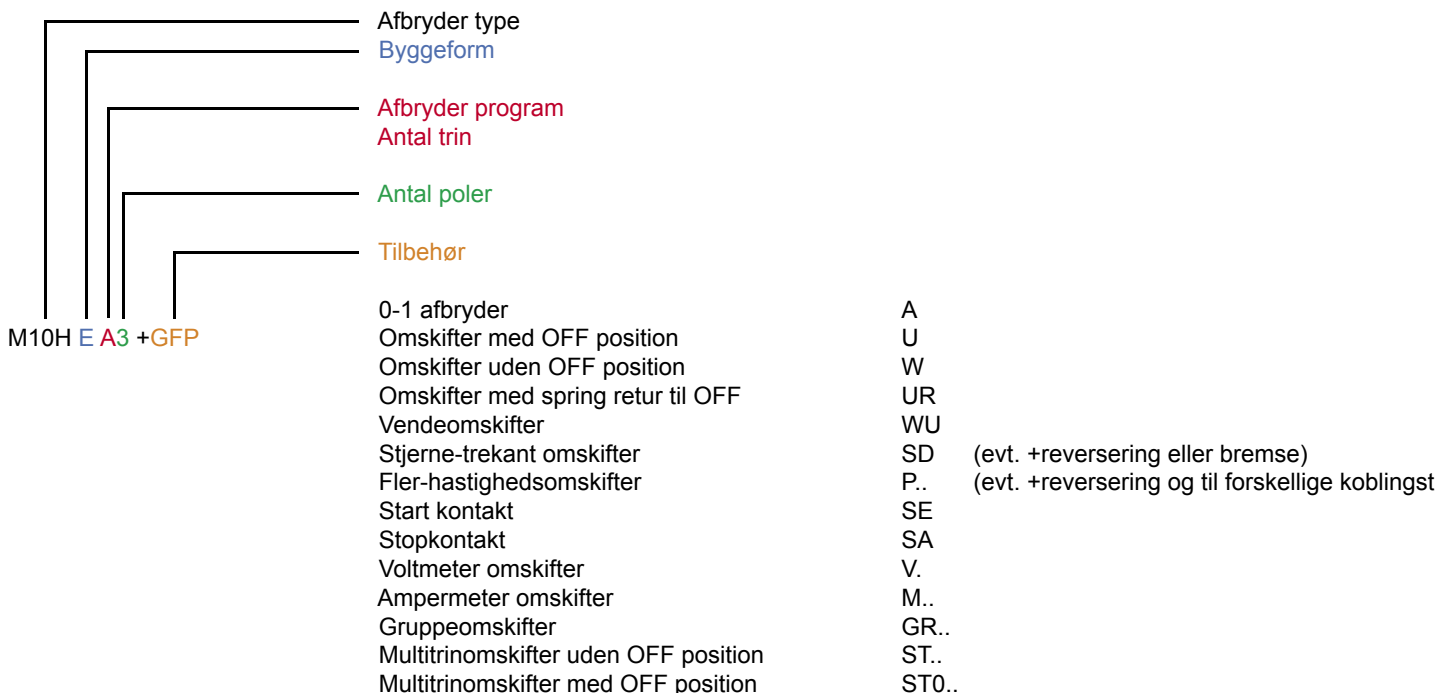
Omskifter opbygning

Typenummer opbygning

Funktion		EAN nr. 9005738+						
			Afbr. størrelse	20A	32A	50A	63A	85A
	Byggeform	Type	M10+	N20+	N33F+	N40+	N60+	N80
Afbryder 3-pol ¹	Frontmont.	+(H) EA3	729774	744432	737021	145093	151353	155856
	Bundmont.	+(H) VA3	797100		765468	149602	154453	190765
	Plastikhus	+PA3	736901	736987	141989	148094		
	Horisontalhus	+PLFA3						
	Siluminhus	+GFA3						
Afbryder 4-pol ¹	Frontmont.	+(H) EA4	740502	740519	759467	145109	151377	155870
	Bundmont.	+(H) VA4	880741			149619	154460	659712
	Plastikhus	+PA4	744753	735935	141996	148100	153708	
	Horisontalhus	+PLFA4						
	Siluminhus	+GFA4		711625				
Omskifter 4-pol	Frontmont.	+(H) EU4	737199	757111	788016	146519	152671	156594
	Bundmont.	+(H) VU4			758804	150998	155702	184078
	Plastikhus	+PU4	765710	754875	143044	149312	154347	849618
	Horisontalhus	+PLFU4					616968	930460
	Siluminhus	+GFU4						
Vendeomskifter 3-pol	Frontmont.	+(H) EWU3	730893	744524	764799	146731	152787	156709
	Bundmont.	+(H) VWU3		772572		151216	155818	648983
	Plastikhus	+PWU3	744814	741752	143242		154415	
	Horisontalhus	+PLFWU3					775702	
	Siluminhus	+GFWU3		128041				
Stjerne- trekantstarter	Frontmont.	+(H) ESD	755735	744456	744067	145741	151933	156433
	Bundmont.	+(H) VSD	829580			150226	154996	201294
	Plastikhus	+PSD	744784	736994	142559	148766	154088	187840
	Horisontalhus	+PLFSD				638038	613127	
	Siluminhus	+GFSD		128027	952564			
Stjerne- trekantstarter m. reversering	Frontmont.	+(H) ESDR	759252	744463	778239	145796	151971	156488
	Bundmont.	+(H) VSDR		766908		150271	155023	
	Plastikhus	+PSDR	770301	744661	142610	148810	717924	
	Horisontalhus	+PLFSDR				638007	553904	
	Siluminhus	+GFSDR		128034				
Stjerne- trekantstarter m. bremse	Frontmont.	+(H) ESDB		773432	787996	145758		
	Bundmont.	+(H) VSDB				150233		
	Plastikhus	+PSDB	954510	771629	142566	148773		
	Horisontalhus	+PLFSDB						
	Siluminhus	+GFSDB		704481				
Dahlander omskifter 1 omdrejningsretning 0 - 1 - 2	Frontmont.	+(H) EP61	757302	744449	846228	145529	151735	156235
	Bundmont.	+(H) VP61				150035	154828	
	Plastikhus	+PP61	744777	755773	142405	148551	154033	
	Horisontalhus	+PLFP61						
	Siluminhus	+GFP61		128010				
Dahlander omskifter 1 omdrejningsretning 1 - 0 - 2	Frontmont.	+(H) EP62	759542	762252	757333	145567	151773	156273
	Bundmont.	+(H) VP62				150073	154866	
	Plastikhus	+PP62	765727	760852	142436	148599	154040	
	Horisontalhus	+PLFP62						
	Siluminhus	+GFP62		711656				
Adskilte viklinger omskifter 1 omdrejningsretning 0 - 1 - 2	Frontmont.	+(H) EP63	843906	793348	846327	145574	151780	156280
	Bundmont.	+(H) VP63				150080	154873	
	Plastikhus	+PP63	811370	847447	142443	148605	154057	
	Horisontalhus	+PLFP63						
	Siluminhus	+GFP63						
Adskilte viklinger omskifter 1 omdrejningsretning 1 - 0 - 2	Frontmont.	+(H) EP64	843913	793522	846334	145581	151797	156297
	Bundmont.	+(H) VP64				150097	154880	
	Plastikhus	+PP64	818010	767172	142450	148612	154064	
	Horisontalhus	+PLFP64						
	Siluminhus	+GFP64		717313				

¹ Afbrydere kan leveres med aflåseligt greb:

Lille greb 2-punktsafslåsning: EH1

Lille greb 2-punktsafslåsning, Rød/gul: EHN1

Stort greb 3-punktsafslåsning: EH4

Stort greb 3-punktsafslåsning, Rød/gul: EHN4

Trinvælgere

Funktion					
M10HE-	Antal trin	2	3	4	5
	Antal poler				
Trinvælger m. nulstilling -ST0TP	1	729811	729828	744241	744255
	2	762955	741561	744258	
	3	744234	741592		
Trinvælger u. nulstilling -STTP	1		678973	744302	
	2		764065	744326	716019
	3		744296		

Tekniske data

Data		M10	M10H	M20	N20	N33F	N40	N60	N80	N100	N200	
Term. mærkestrøm I_{th}	A	20	20	32	32	50	63	85	115	150	250	
Mærkespænding U_e	V	440	690	690	690	690	690	690	690	690	690	
Koblingsværdi AC21	A	20	20	32	32	50	63	85	115	150	250	
Koblingsværdi AC23	A	16	16	30	30	45	45	60	85	105	135	
Koblingsværdi Y-D starter	220-240V	kW	3,7	3,7	7,5	7,5	8	11	15	18,5	22	40
	380-415V	kW	7,5	7,5	15	15	18,5	18,5	25	30	40	70
Koblingsværdi AC3	220-240V	kW	3	3	5,5	5,5	7,5	7,5	15	18,5	22	40
	380-440V	kW	5,5	5,5	11	11	15	15	25	30	40	70
Ledningstværsnit (multicore)	mm ²	0,75-2,5	0,75-2,5	1-4	1-4	1,5-6	2,5-10	6-25	6-35	10-35	35-120	
Kortslutningsbeskyttelse max sikr. gL/gG	A	20	20	35	35	50	63	100	125	160	250	
Effekttab pr. pol	W	0,6	0,5	0,9	1,1	1,9	2	2,8	4,4	5,7	21	

Dimensioner

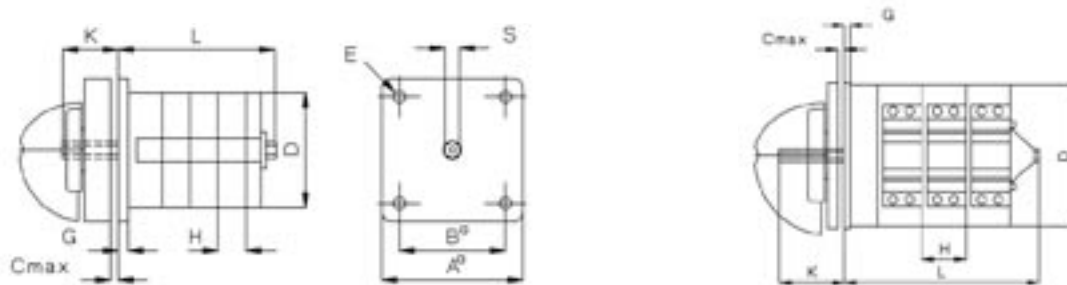





Type	A	B	C	D	D1	D2	D3	E	G	H	K	S
M10H	48	36	5	43	5	8		4	3,5	9,5	19	SW5
M20	48	36	5	56	5	8	57	4	3,5	12,5	19	SW5
N20	64	48	5	56	5	12	57	4,2	3	12,5	20	SW7
N33F	64	48	5	58	5	12		4,2	3	15,5	20	SW7
N40	86	68	7	80	6	12	82	4,2	3,5	18	24,5	SW9
N60	86	68	7	80	6	12	82	5,2	3,5	29,5	24,5	SW9
N80	86	68	7	80	6	12	82	5,2	3,5	29,5	24,5	SW9
N100	132	110	9	128	7	16	129	6,2	5	30	37	SW12



Dimension L med antal celler (2-kontaktfunktioner pr. celle)

Type	1	2	3	4	5	6	7	8	9	10	11	12	13	14	15
M10H	36,5	46	55,5	65	74,5	84	93,5	103	112,5	122	131,5	141			
M20	38,5	51	63,5	76	88,5	101	113,5	126	138,5	151	163,5	176			
N20	40,5	53	65,5	78	90,5	103	115,5	128	140,5	153	165,5	178	190,5	203	215,5
N33F	44	59,5	75	90,5	106	121,5	137	152,5	168	183,5	199	214,5	230	245,5	261
N40	52,5	70,5	88,5	106,5	124,5	142,5	160,5	178,5	196,5	214,5	232,5	250,5	268,5	286,5	304,5
N60	64	93,5	123	152,5	182	211,5	241	270,5	300	329,5	359	388,5			
N80	64	93,5	123	152,5	182	211,5	241	270,5	300	329,5	359	388,5			
N100	88	118	148	178	208	238	268	298	328	358	388	418			
N200	96	136	176	216	256	296	336	376	416	456	496	536			

LTS afbrydere

Montage		Greb	Poler	A	Varenr	EAN-nr
Frontmonteret		Standard	3	20	LTS20EA3	9005738924605
				25	LTS25EA3	9005738926791
				32	LTS32EA3	9005738927064
				40	LTS40EA3	9005738928566
				63	LTS63EA3	9005738941879
				80	LTS80EA3	9005738942425
			4	20	LTS20EA4	9005738924629
				25	LTS25EA4	9005738926807
				32	LTS32EA4	9005738927071
				40	LTS40EA4	9005738928573
				63	LTS63EA4	9005738941886
				80	LTS80EA4	9005738942432
		Aflåselige Sort 2 hængelåse	3	20	LTS20EH1A3	9005738924643
				25	LTS25EH1A3	9005738926814
				32	LTS32EH1A3	9005738927095
				40	LTS40EH1A3	9005738928580
				63	LTS63EH1A3	9005738941909
				80	LTS80EH1A3	9005738942449
			4	20	LTS20EH1A4	9005738924650
				25	LTS25EH1A4	9005738926821
				32	LTS32EH1A4	9005738927101
				40	LTS40EH1A4	9005738928597
				63	LTS63EH1A4	9005738941916
				80	LTS80EH1A4	9005738942456
		Aflåselige Sort 3 hængelåse	3	20	LTS20EH4A3	9005738924667
				25	LTS25EH4A3	9005738925893
				32	LTS32EH4A3	9005738925909
				40	LTS40EH4A3	9005738925916
				63	LTS63EH4A3	9005738925923
				80	LTS80EH4A3	9005738925930
			4	20	LTS20EH4A4	9005738924674
				25	LTS25EH4A4	9005738925947
				32	LTS32EH4A4	9005738925954
				40	LTS40EH4A4	9005738925961
				63	LTS63EH4A4	9005738925978
				80	LTS80EH4A4	9005738925985
	Aflåselige Rød 2 hængelåse	3	20	LTS20EHN1A3	9005738924681	
			25	LTS25EHN1A3	9005738926845	
			32	LTS32EHN1A3	9005738927118	
			40	LTS40EHN1A3	9005738928603	
			63	LTS63EHN1A3	9005738941930	
			80	LTS80EHN1A3	9005738942463	
		4	20	LTS20EHN1A4	9005738924698	
			25	LTS25EHN1A4	9005738926852	
			32	LTS32EHN1A4	9005738927125	
			40	LTS40EHN1A4	9005738928627	
			63	LTS63EHN1A4	9005738941947	
			80	LTS80EHN1A4	9005738942470	
	Aflåselige Rød 3 hængelåse	3	20	LTS20EHN4A3	9005738924704	
			25	LTS25EHN4A3	9005738925701	
			32	LTS32EHN4A3	9005738925718	
			40	LTS40EHN4A3	9005738925725	
			63	LTS63EHN4A3	9005738921154	
			80	LTS80EHN4A3	9005738921161	
		4	20	LTS20EHN4A4	9005738924711	
			25	LTS25EHN4A4	9005738925732	
			32	LTS32EHN4A4	9005738925749	
			40	LTS40EHN4A4	9005738925756	
			63	LTS63EHN4A4	9005738920935	
			80	LTS80EHN4A4	9005738920942	

LTS afbrydere







						Sikkerhedsafbrydere		
Type	Mærkestrøm		Motor			Frontmonteret	Et-huls mon- tage Ø22,5	Bundmontage
						IP65	IP65	IP65
	I_{th}	AC21	AC3 3x400V	AC23 3x400V				
	A	A	kW	A	kW			
LTS20	20	20	5,5	16	7,5	...EHN1.. ...EHN4..	...ZHN1..	...VHN4.. ...VZVHN4..
LTS25	25	25	7,5	20	10			
LTS32	32	32	11	25	12,5			
LTS40	40	40	15	32	16			
LTS63	63	63	18,5	45	22			
LTS80	80	80	18,5	45	22			

Afbryder program:

3-polet afbryder LTS.....A3
 4-polet afbryder LTS.....A4
 6-polet afbryder LTS.....A6
 8-polet afbryder LTS.....A8

3-polet omskifter LTS.....U3
 4-polet omskifter LTS.....U4

Tilbehør				
			Frontmonterede	Bundmonteret
	4-pol	f. LTS20 - LTS40	N40E	N40V
		f. LTS63 - LTS80	N80E	N80V
	Hjælpekontakt 1NO + 1 NC	f. LTS20 - LTS80	LH11	LH11
	Hjælpekontakt 1 NO + 1 NC overlappende	f. LTS20 - LTS80	LH11X	LH11X
	Hjælpekontakt 2NC	f. LTS20 - LTS80	LH20V/02E	LH20V/02E
	PE Terminal	f. LTS20 - LTS80	PE80E	PE80V
	N Terminal	f. LTS20 - LTS80	PEN80E	PEN80V
	Klemafdækning 3-pol.	f. LTS20 - LTS40	KLAD70	KLAD40
		f. LTS63 - LTS80		KLAD70
	Klemafdækning 4. pol, effektreds	f. LTS20 - LTS40	KLAD70N	
		f. LTS63 - LTS80		KLAD70N
	Klemafdækning 4. pol, styrestrom	f. LTS20 - LTS40	KLAD70NI	
		f. LTS63 - LTS80		KLAD70NI

Sikkerhedsafbrydere			Reparationsafbryder		Afbryder	
Bundmontage fast aksell.	Gruppeindb.	Kapsling	Frontmonteret	Bundmonteret	Frontmonteret	Gruppeindb.
IP65	IP40	IP65	IP65	IP65	IP65	IP40
						
...VZHN1.. ...VZHN4..	...SMAHN1..	...PFHN4..	...EH1.. ...EH4..	...VZVH4.. ...VH4..	...E..	...SMA..

LTS Dimensioner

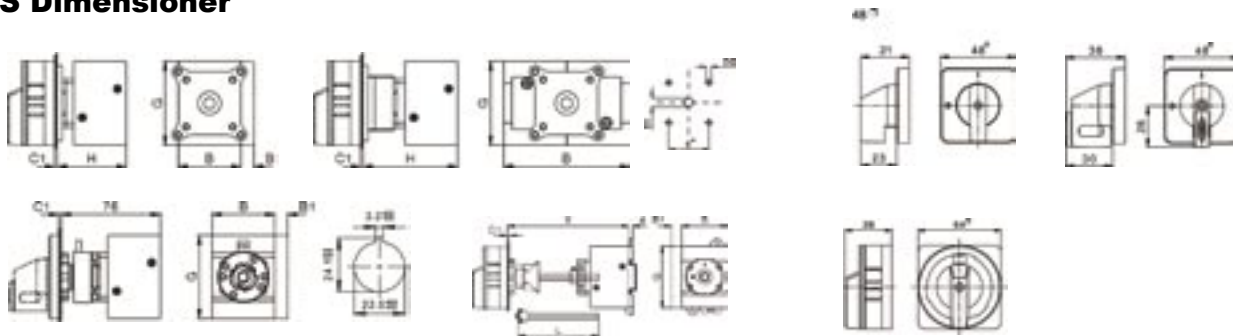

Type	Skilt		3-pol	4-pol	6-pol	8-pol	Hj.kont	4. pol							3-pol 4-pol	6-pol 8-pol
		A	B	B	B	B	B1	B2	C1	D1	D2	E	F	G	H	H
LTS	48x48	48	48	62,5			10	14,5	1-5	10	5	36		64	54	
LTS	64x64	64	48	62,5	97	126	10	14,5	1-5	10	5	48		64	54	74

LTS Tekniske data

		LTS20	LTS25	LTS32	LTS40	LTS63	LTS80
Hovedkontaktsæt							
Mærkestrøm I_{th}	A	20	25	32	40	63	80
Mærke isolationsspænding U_i	V	690	690	690	690	690	690
Mærkestrøm I_e AC21	A	20	25	32	40	63	80
Slutteevne I_{eff} 3x380-440V	A	160	190	220	300	370	440
Brydeevne 3x220-240V	A	160	180	200	250	330	380
3x380-440V	A	160	180	200	250	330	380
3x660-690V	A	80	110	140	170	190	220
Motorafbryder AC3	A	12	16	23	30	37	37
3x220-240V	kW	3	4	5,5	7,5	11	11
Hovedafbryder AC23 3x400V	A	16	20	25	32	45	45
Max. forsikring gL(gG)	A	25	35	40	50	63	80
Ledningsstørrelse, massiv leder	mm ²	10	10	10	10	25	25
Ledningsstørrelse, fleksibel leder	mm ²	6	6	6	6	16	16
Hjælpekaraktersæt							
Mærke isolationsspænding U_i	V	690	690	690	690	690	690
Mærkestrøm I_{th}	A	10	10	10	10	10	10
Koblingsevne AC15 220-240	A	2,5	2,5	2,5	2,5	2,5	2,5
Koblingsevne AC15 380-440	A	1,5	1,5	1,5	1,5	1,5	1,5
Max. forsikring gL(gG)	A	10	10	10	10	10	10
Ledningsstørrelse, massiv leder	mm ²	2,5	2,5	2,5	2,5	2,5	2,5
Ledningsstørrelse, fleksibel leder	mm ²	2,5	2,5	2,5	2,5	2,5	2,5

Yderligere information hos:

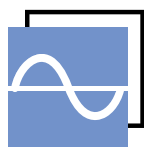

MTO
electric a/s

Stiftsvej 14
DK-7100 Vejle
Tlf.: +45 75 800 310
Fax: +45 75 800 320

mail: info@mto-electric.dk
www.mto-electric.dk

We care for you...