



ACCESSORI MC

p. 26/29

ACCESSORIES FOR CABINETS

p. 46/61

• PARTITION BAFFLES



• REAR DOORS



• OVERDOOR PANELS



• SKIRTING



MODULAR CABINETS SERIES MC

- Material: s/s EN 1.4301 (AISI 304), finely satin-finished and protected, thickness 15/10 for side and back panels, thickness 20/10 for frame and door
- Frame: heavy-duty structure made from s/s section bars, with drills spaced 25mm for installation of accessories, if required.
- Front door, blind version or with glass (crash-proof 3+3 safety glass), with stiffening S/S frame, drilled, to support equipment and/or secure cableducts and accessories. On request the blind door can also be equipped with partial windows and different materials can be used (polycarbonate or aluminium for silk printing)
- Blind back panel, bolted, with sealing spacers (on request it can be replaced by a hinged door – see “Accessories for MC cabinets”).
- Side panels, removable and bolted, to be ordered separately (see “Accessories for MC cabinets”)
- Twin-comb door lock with outside faceplate of glass-loaded black polyamides, 4-point closing and BT. key. On request it can be replaced by other types of door locks (see “accessories for cabinets”)
- Fairlead plate with 3-part seal
- AISI 316 s/s inner hinges, for 120° opening as per CEI EN 60204-1 recommendations
- Maximum weight the door can stand: 30 kg
- Seal of foamed polyurethane, applied by robotized system
- Inner plate of sendzimir to be ordered separately (see “Accessories for MC cabinets”)
- Pre-arranged for earthing in compliance with the applicable laws force
- Protection degree: IP66 (modules L.1200 IP65)

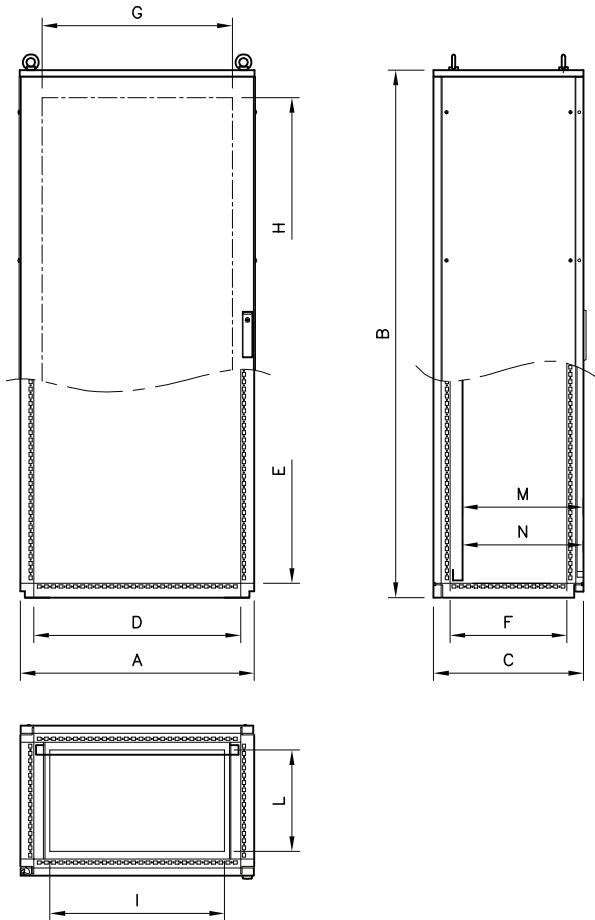

Blind door version

Tested by
KEMA Quality Italy

IP66

EN 60 529



TYPE NEMA 4X, 4, 12, 1

Standard UL508A - UL50
Standard 250



EN 60204-1
89/392/EEC

CABINET													OPTIONALS			
ITEM.	frame inner side			door useful size		cable entry						INNER PLATE			SIDE PANELS	
	A	B	C	D	E	F	G	H	I	L	M**	N**	ITEM. *	X	Y	ITEM.
MC0685	605	1815	515	512	1712	402	455	1630	400	350	456	420	PA0717	497	1692	MC85
MC0686	605	1815	615	512	1712	502	455	1630	400	450	556	520	PA0517	497	1692	MC86
MC0688	605	1815	815	512	1712	702	455	1630	400	650	756	720	PA0517	497	1692	MC88
MC0885	805	1815	515	712	1712	402	655	1630	600	350	456	420	PA0717	697	1692	MC85
MC0886	805	1815	615	712	1712	502	655	1630	600	450	556	520	PA0717	697	1692	MC86
MC0888	805	1815	815	712	1712	702	655	1630	600	650	756	720	PA0717	697	1692	MC88
MC1085	1005	1815	515	912	1712	402	855	1630	800	350	456	420	PA0917	897	1692	MC85
MC1086	1005	1815	615	912	1712	502	855	1630	800	450	556	520	PA0917	897	1692	MC86
MC1088	1005	1815	815	912	1712	702	855	1630	800	650	756	720	PA0917	897	1692	MC88
MC0605	605	2015	515	512	1912	402	455	1830	400	350	456	420	PA0519	497	1892	MC05
MC0606	605	2015	615	512	1912	502	455	1830	400	450	556	520	PA0519	497	1892	MC06
MC0608	605	2015	815	512	1912	702	455	1830	400	650	756	720	PA0519	497	1892	MC08
MC0805	805	2015	515	712	1912	402	655	1830	600	350	456	420	PA0719	697	1892	MC05
MC0806	805	2015	615	712	1912	502	655	1830	600	450	556	520	PA0719	697	1892	MC06
MC0808	805	2015	815	712	1912	702	655	1830	600	650	756	720	PA0719	697	1892	MC08
MC1005	1005	2015	515	912	1912	402	855	1830	800	350	456	420	PA0919	897	1892	MC05
MC1006	1005	2015	615	912	1912	502	855	1830	800	450	556	520	PA0919	897	1892	MC06
MC1008	1005	2015	815	912	1912	702	855	1830	800	650	756	720	PA0919	897	1892	MC08

REMARK: Total width, side panels included: dim: "A" + 9 mm

**M Max. distance between door inside and inner plate, when fixing is by stirrups
**N Max. distance between door inside and inner plate, when fixing is by slides

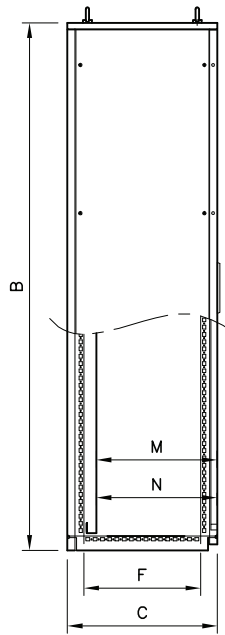
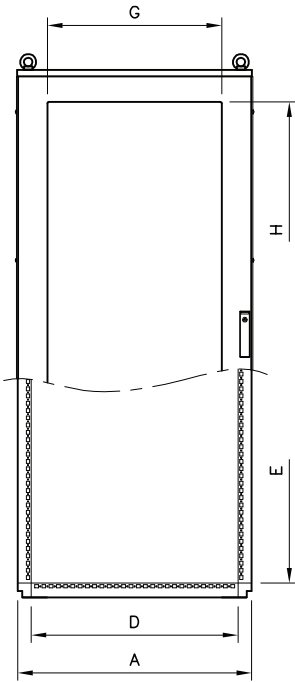

Door with glass

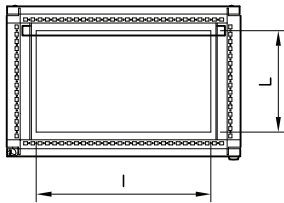
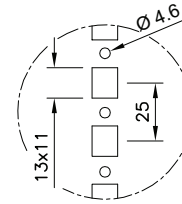

Tested by KEMA Quality Italy	IP66	EN 60 529
	TYPE NEMA 4X, 4, 12, 1	Standard UL508A - UL50 Standard 250
		EN 60204-1 89/392/EEC

CABINET													OPTIONALS			
ITEM.	Frame inner side			Visibile size		cable entry					INNER PLAGE			SIDE PANELS		
	A	B	C	D	E	F	G	H	I	L	M**	N**	ITEM. *	X	Y	ITEM.
MCV0685	605	1815	515	512	1712	402	400	1600	400	350	450	414	PA0517	497	1692	MC85
MCV0686	605	1815	615	512	1712	502	400	1600	400	450	550	514	PA0517	497	1692	MC86
MCV0688	605	1815	815	512	1712	702	400	1600	400	650	750	714	PA0517	497	1692	MC88
MCV0885	805	1815	515	712	1712	402	600	1600	600	350	450	414	PA0717	697	1692	MC85
MCV0886	805	1815	615	712	1712	502	600	1600	600	450	550	514	PA0717	697	1692	MC86
MCV0888	805	1815	815	712	1712	702	600	1600	600	650	750	714	PA0717	697	1692	MC88
MCV1085	1005	1815	515	912	1712	402	800	1600	800	350	450	414	PA0917	897	1692	MC85
MCV1086	1005	1815	615	912	1712	502	800	1600	800	450	550	514	PA0917	897	1692	MC86
MCV1088	1005	1815	815	912	1712	702	800	1600	800	650	750	714	PA0917	897	1692	MC88
MCV0605	605	2015	515	512	1912	402	400	1800	400	350	450	414	PA0519	497	1892	MC05
MCV0606	605	2015	615	512	1912	502	400	1800	400	450	550	514	PA0519	497	1892	MC06
MCV0608	605	2015	815	512	1912	702	400	1800	400	650	750	714	PA0519	497	1892	MC08
MCV0805	805	2015	515	712	1912	402	600	1800	600	350	450	414	PA0719	697	1892	MC05
MCV0806	805	2015	615	712	1912	502	600	1800	600	450	550	514	PA0719	697	1892	MC06
MCV0808	805	2015	815	712	1912	702	600	1800	600	650	750	714	PA0719	697	1892	MC08
MCV1005	1005	2015	515	912	1912	402	800	1800	800	350	450	414	PA0919	897	1892	MC05
MCV1006	1005	2015	615	912	1912	502	800	1800	800	450	550	514	PA0919	897	1892	MC06
MCV1008	1005	2015	815	912	1912	702	800	1800	800	650	750	714	PA0919	897	1892	MC08

REMARK: Total width side panels included: dim: "A" + 9 mm

**M Max. distance between door inside and inner plate, when fixing is by stirrups
**N Max. distance between door inside and inner plate, when fixing is by slides

* see accessories on page 36

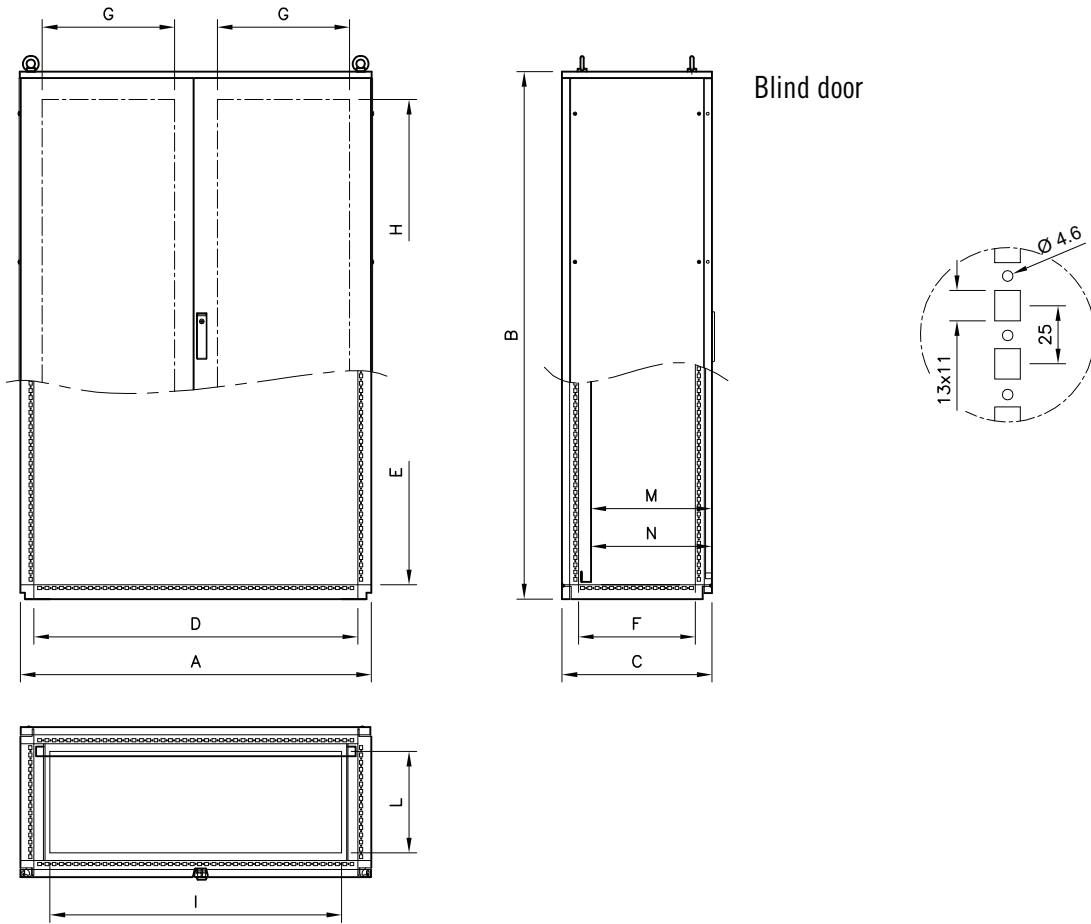

		IP65	EN 60 529
	TYPE NEMA	12, 1	Standard UL508A - UL50 Standard 250
			EN 60204-1 89/392/EEC

CABINET													OPTIONALS			
ITEM.	Frame inner size			Door useful size		Cable entry					INNER. PLATES			SIDE PANELS		
	A	B	C	D	E	F	G	H	I	L	M**	N**	ITEM.*	X	Y	ITEM.
MC1285	1208	1815	515	1115	1712	402	455	1630	1004	350	456	420	PA1117	1100	1692	MC85
MC1286	1208	1815	615	1115	1712	502	455	1630	1004	450	556	520	PA1117	1100	1692	MC86
MC1288	1208	1815	815	1115	1712	702	455	1630	1004	650	756	720	PA1117	1100	1692	MC88
MC1205	1208	2015	515	1115	1912	402	455	1830	1004	350	456	420	PA1119	1100	1892	MC05
MC1206	1208	2015	615	1115	1912	502	455	1830	1004	450	556	520	PA1119	1100	1892	MC06
MC1208	1208	2015	815	1115	1912	702	455	1830	1004	650	756	720	PA1119	1100	1892	MC08

REMARK: Total width side panels included: dim: "A" + 9 mm

**M Max. distance between door inside and inner plate, when fixing is by stirrups
 **N Max. distance between door inside and inner plate, when fixing is by slides

* see accessories on page 36

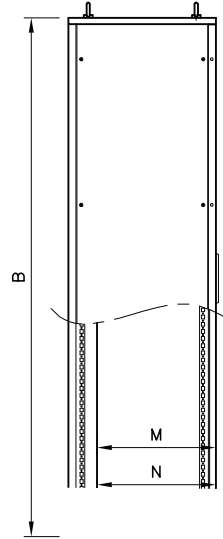
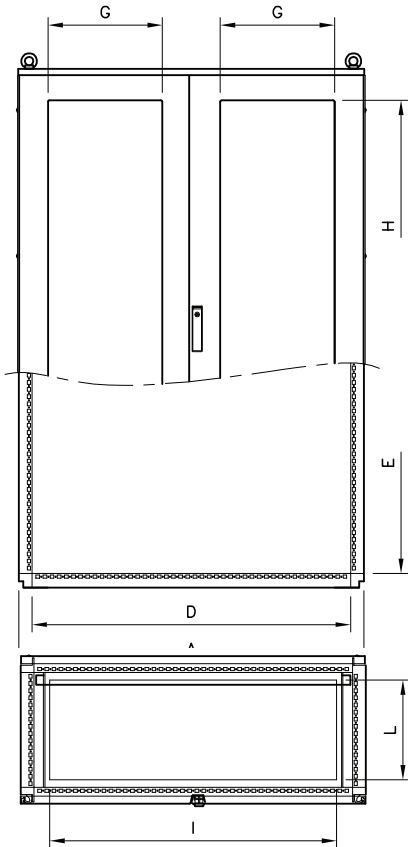

Door with glass

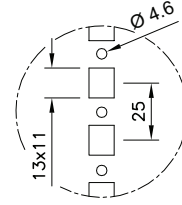
IP65 EN 60 529

TYPE NEMA 12, 1

Standard UL508A - UL50 Standard 250



EN 60204-1 89/392/EEC

CABINET											OPTIONAL						
ITEM.	A	B	C	Frame inner side			Visibile size		Cable entry		Remarks	M**	N**	INNER PLATES			SIDE PANELS
				D	E	F	G	H	I	L				ITEM. *	X	Y	ITEM.
MCV1285SX	1208	1815	515	1115	1712	402	400	1600	1004	350	left door with glass	450	414	PA1117	1100	1692	MC85
MCV1285DX	1208	1815	515	1115	1712	402	400	1600	1004	350	right door with glass	450	414	PA1117	1100	1692	MC85
MCV1285	1208	1815	515	1115	1712	402	400	1600	1004	350	both doors with glass	450	414	PA1117	1100	1692	MC85
MCV1286SX	1208	1815	615	1115	1712	502	400	1600	1004	450	left door with glass	550	514	PA1117	1100	1692	MC86
MCV1286DX	1208	1815	615	1115	1712	502	400	1600	1004	450	right door with glass	550	514	PA1117	1100	1692	MC86
MCV1286	1208	1815	615	1115	1712	502	400	1600	1004	450	both doors with glass	550	514	PA1117	1100	1692	MC86
MCV1288SX	1208	1815	815	1115	1712	702	400	1600	1004	650	left door with glass	750	714	PA1117	1100	1692	MC88
MCV1288DX	1208	1815	815	1115	1712	702	400	1600	1004	650	right door with glass	750	714	PA1117	1100	1692	MC88
MCV1288	1208	1815	815	1115	1712	702	400	1600	1004	650	both doors with glass	750	714	PA1117	1100	1692	MC88
MCV1205SX	1208	2015	515	1115	1912	402	400	1800	1004	350	left door with glass	450	414	PA1119	1100	1892	MC05
MCV1205DX	1208	2015	515	1115	1912	402	400	1800	1004	350	right door with glass	450	414	PA1119	1100	1892	MC05
MCV1205	1208	2015	515	1115	1912	402	400	1800	1004	350	both doors with glass	450	414	PA1119	1100	1892	MC05
MCV1206SX	1208	2015	615	1115	1912	502	400	1800	1004	450	left door with glass	550	514	PA1119	1100	1892	MC06
MCV1206DX	1208	2015	615	1115	1912	502	400	1800	1004	450	right door with glass	550	514	PA1119	1100	1892	MC06
MCV1206	1208	2015	615	1115	1912	502	400	1800	1004	450	both doors with glass	550	514	PA1119	1100	1892	MC06
MCV1208SX	1208	2015	815	1115	1912	702	400	1800	1004	650	left door with glass	750	714	PA1119	1100	1892	MC08
MCV1208DX	1208	2015	815	1115	1912	702	400	1800	1004	650	right door with glass	750	714	PA1119	1100	1892	MC08
MCV1208	1208	2015	815	1115	1912	702	400	1800	1004	650	both doors with glass	750	714	PA1119	1100	1892	MC08

REMARK: Total width side panels included: dim: "A" + 9 mm

 **M Distance max entre façade interne de la porte et plaque interne de fixation par étrier
 **N Distance max entre interne porte et plaque interne en cas de fixation par glissières

* see accessories on page 36

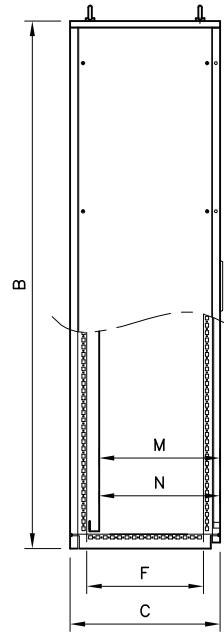
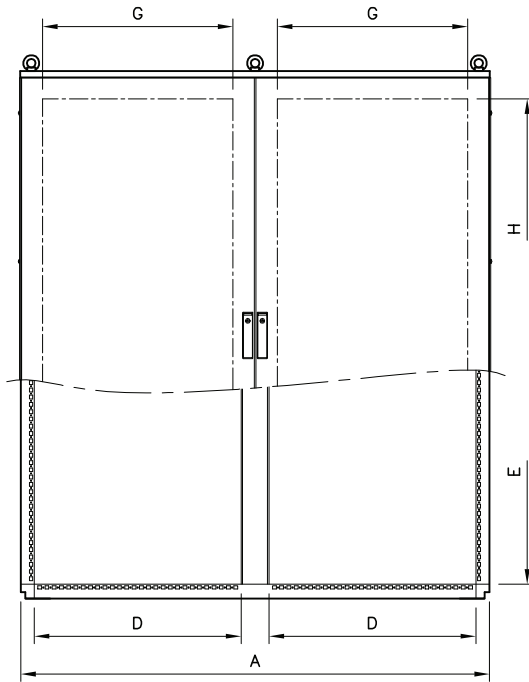

Blind door

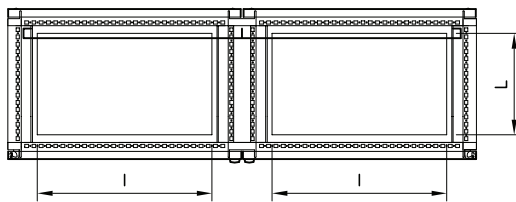
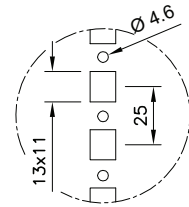

Tested by
KEMA Quality Italy

IP66

EN 60 529



TYPE
NEMA

4X, 4, 12, 1

Standard UL508A - UL50
Standard 250



EN 60204-1
89/392/EEC

CABINET													OPTIONALS			
ITEM.	Frame inner side						Door useful size		Cable entry		M**	N**	INNER PLATES			SIDE PANELS
	A	B	C	D	E	F	G	H	I	L			ITEM.*	X	Y	
MC1685	1613	1815	515	712	1712	402	655	1630	600	350	450	414	PA1517	1505	1692	MC85
MC1686	1613	1815	615	712	1712	502	655	1630	600	450	550	514	PA1517	1505	1692	MC86
MC1688	1613	1815	815	712	1712	702	655	1630	600	650	750	714	PA1517	1505	1692	MC88
MC1605	1613	2015	515	712	1912	402	655	1830	600	350	450	414	PA1519	1505	1892	MC05
MC1606	1613	2015	615	712	1912	502	655	1830	600	450	550	514	PA1519	1505	1892	MC06
MC1608	1613	2015	815	712	1912	702	655	1830	600	650	750	714	PA1519	1505	1892	MC08

REMARK: Total width side panels included: dim: "A" + 9 mm

**M Max. distance between door inside and inner plate, when fixing is by stirrups

**N Max. distance between door inside and inner plate, when fixing is by slides

* see accessories on page 36

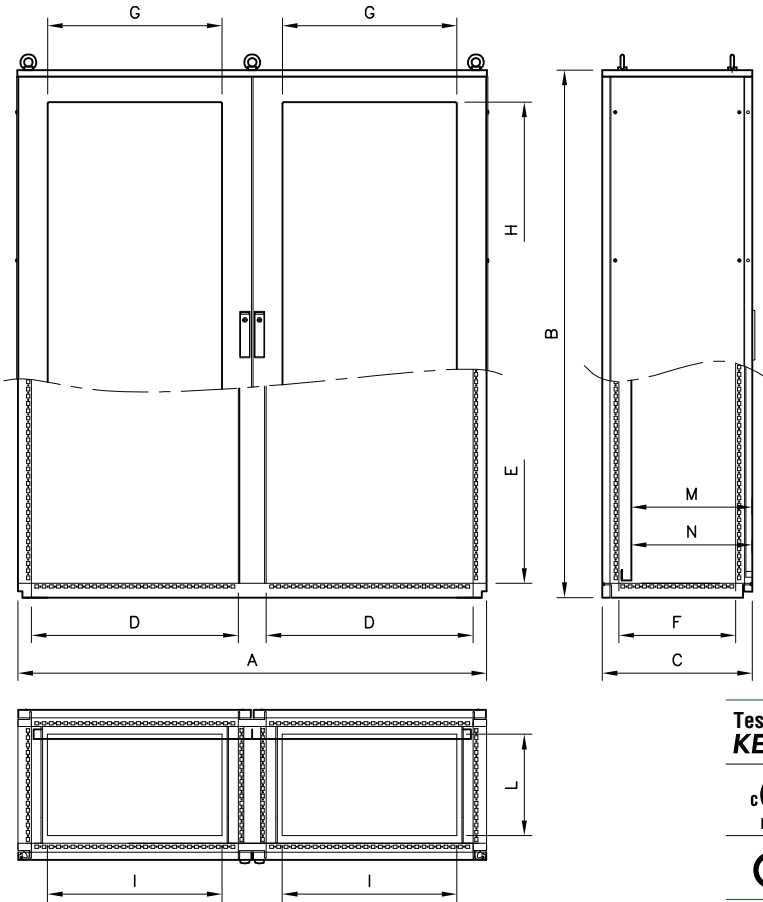

Door with glass

Tested by KEMA Quality Italy	IP66	EN 60 529
	TYPE NEMA 4X, 4, 12, 1	Standard UL508A - UL50 Standard 250
		EN 60204-1 89/392/EEC

CABINET												OPTIONAL					
ITEM.	Frame inner side			Visibile size		Cable entry		Remark		INNER PLATES			SIDE PANELS ITEM.				
	A	B	C	D	E	F	G	H	I	L	M**	N**		ITEM. *	X	Y	
MCV1685SX	1613	1815	515	712	1712	402	600	1600	600	350	450	414	left door with glass	PA1517	1505	1697	MC85
MCV1685DX	1613	1815	515	712	1712	402	600	1600	600	350	450	414	right door with glass	PA1517	1505	1697	MC85
MCV1685	1613	1815	515	712	1712	402	600	1600	600	350	450	414	both doors with glass	PA1517	1505	1697	MC85
MCV1686SX	1613	1815	615	712	1712	502	600	1600	600	450	550	514	left door with glass	PA1517	1505	1697	MC86
MCV1686DX	1613	1815	615	712	1712	502	600	1600	600	450	550	514	right door with glass	PA1517	1505	1697	MC86
MCV1686	1613	1815	615	712	1712	502	600	1600	600	450	550	514	both doors with glass	PA1517	1505	1697	MC86
MCV1688SX	1613	1815	815	712	1712	702	600	1600	600	650	750	714	left door with glass	PA1517	1505	1697	MC88
MCV1688DX	1613	1815	815	712	1712	702	600	1600	600	650	750	714	right door with glass	PA1517	1505	1697	MC88
MCV1688	1613	1815	815	712	1712	702	600	1600	600	650	750	714	both doors with glass	PA1517	1505	1697	MC88
MCV1605SX	1613	2015	515	712	1912	402	600	1800	600	350	450	414	left door with glass	PA1519	1505	1897	MC05
MCV1605DX	1613	2015	515	712	1912	402	600	1800	600	350	450	414	right door with glass	PA1519	1505	1897	MC05
MCV1605	1613	2015	515	712	1912	402	600	1800	600	350	450	414	both doors with glass	PA1519	1505	1897	MC05
MCV1606SX	1613	2015	615	712	1912	502	600	1800	600	450	550	514	left door with glass	PA1519	1505	1897	MC06
MCV1606DX	1613	2015	615	712	1912	502	600	1800	600	450	550	514	right door with glass	PA1519	1505	1897	MC06
MCV1606	1613	2015	615	712	1912	502	600	1800	600	450	550	514	both doors with glass	PA1519	1505	1897	MC06
MCV1608SX	1613	2015	815	712	1912	702	600	1800	600	650	750	714	left door with glass	PA1519	1505	1897	MC08
MCV1608DX	1613	2015	815	712	1912	702	600	1800	600	650	750	714	right door with glass	PA1519	1505	1897	MC08
MCV1608	1613	2015	815	712	1912	702	600	1800	600	650	750	714	both doors with glass	PA1519	1505	1897	MC08

REMARK: Total width side panels included: dim: "A" + 9 mm

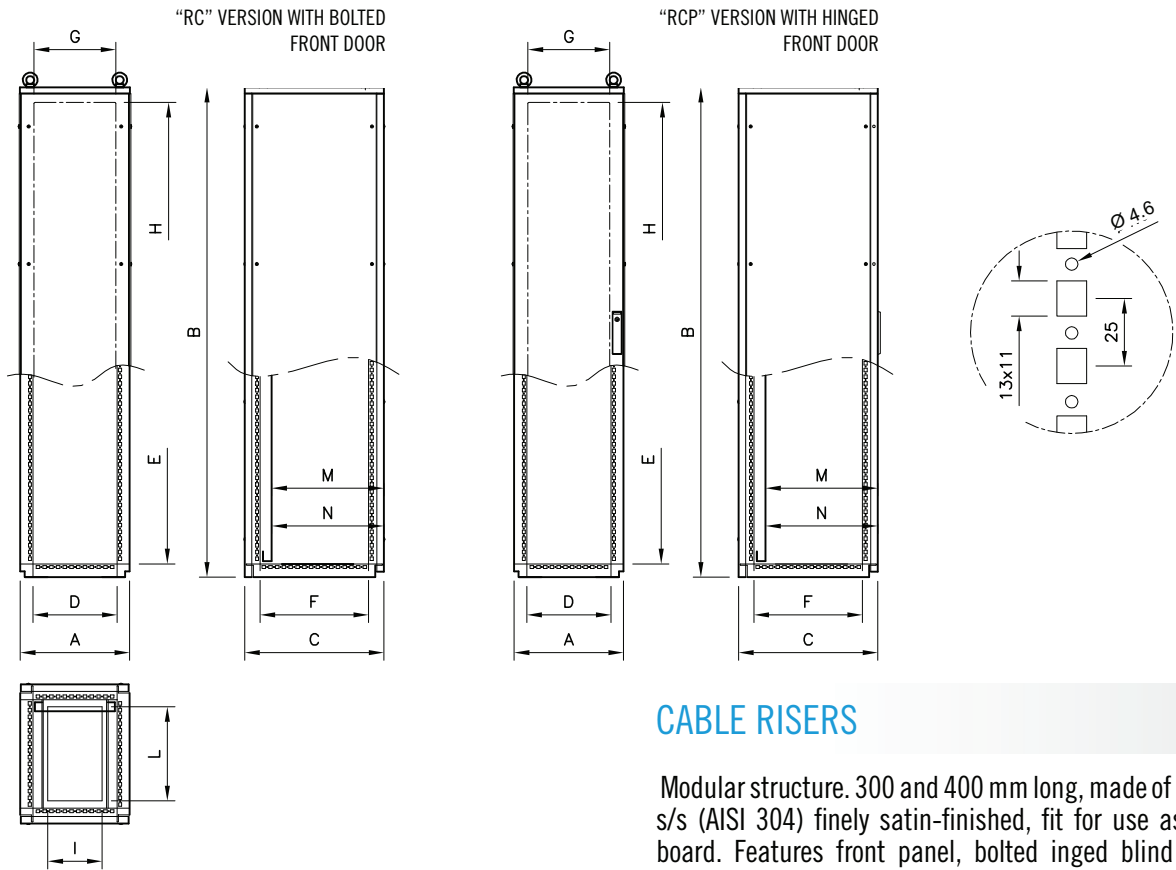

**M Distance max entre façade interne de la porte et plaque interne de fixation par étrier
**N Distance max entre interne porte et plaque interne en cas de fixation par glissières

* see accessories on page 36



CABLE RISERS

Modular structure. 300 and 400 mm long, made of EN 1.4301 s/s (AISI 304) finely satin-finished, fit for use as terminal board. Features front panel, bolted inged blind door and back panel bolted and removable to guarantee accessibility on both sides. Prearranged to receive standard side panels, partition baffles and plinths h.100 and 200 mm. Available in 3 different depths and two heights, to match perfectly all types of modular cabinets. Protection degree: IP66.

Tested by KEMA Quality Italy	IP66	EN 60 529
	TYPE NEMA 4X, 4, 12, 1	Standard UL508A - UL50 Standard 250
		EN 60204-1 89/392/EEC

ITEM.	CABINET												OPTIONAL			
	A	B	C	Frame inner size			Door useful size		Cable entry		M**	N**	INNER PLATES			SIDE PANELS
				D	E	F	G	H	I	L			ITEM.*	X	Y	ITEM.
RC0385	305	1815	515	212	1712	402	203	1706	100	350	450	414	PA0217	197	1692	MC85
RC0386	305	1815	615	212	1712	502	203	1706	100	450	550	514	PA0217	197	1692	MC86
RC0388	305	1815	815	212	1712	702	203	1706	100	650	750	714	PA0217	197	1692	MC88
RC0305	305	2015	515	212	1912	402	203	1906	100	350	450	414	PA0219	197	1892	MC05
RC0306	305	2015	615	212	1912	502	203	1906	100	450	550	514	PA0219	197	1892	MC06
RC0308	305	2015	815	212	1912	702	203	1906	100	650	750	714	PA0219	197	1892	MC08
RC0485	405	1815	515	312	1712	402	303	1706	200	350	450	414	PA0317	297	1692	MC85
RC0486	405	1815	615	312	1712	502	303	1706	200	450	550	514	PA0317	297	1692	MC86
RC0488	405	1815	815	312	1712	702	303	1706	200	650	750	714	PA0317	297	1692	MC88
RC0405	405	2015	515	312	1912	402	303	1906	200	350	450	414	PA0319	297	1892	MC05
RC0406	405	2015	615	312	1912	502	303	1906	200	450	550	514	PA0319	297	1892	MC06
RC0408	405	2015	815	312	1912	702	303	1906	200	650	750	714	PA0319	297	1892	MC08
RCP0385	305	1815	515	212	1712	402	203	1706	100	350	450	414	PA0217	197	1692	MC85
RCP0386	305	1815	615	212	1712	502	203	1706	100	450	550	514	PA0217	197	1692	MC86
RCP0388	305	1815	815	212	1712	702	203	1706	100	650	750	714	PA0217	197	1692	MC88
RCP0305	305	2015	515	212	1912	402	203	1906	100	350	450	414	PA0219	197	1892	MC05
RCP0306	305	2015	615	212	1912	502	203	1906	100	450	550	514	PA0219	197	1892	MC06
RCP0308	305	2015	815	212	1912	702	203	1906	100	650	750	714	PA0219	197	1892	MC08
RCP0485	405	1815	515	312	1712	402	303	1706	200	350	450	414	PA0317	297	1692	MC85
RCP0486	405	1815	615	312	1712	502	303	1706	200	450	550	514	PA0317	297	1692	MC86
RCP0488	405	1815	815	312	1712	702	303	1706	200	650	750	714	PA0317	297	1692	MC88
RCP0405	405	2015	515	312	1912	402	303	1906	200	350	450	414	PA0319	297	1892	MC05
RCP0406	405	2015	615	312	1912	502	303	1906	200	450	550	514	PA0319	297	1892	MC06
RCP0408	405	2015	815	312	1912	702	303	1906	200	650	750	714	PA0319	297	1892	MC08

REMARK: Total width side panels included: dim: "A" + 9 mm

**M Max. distance between door inside and inner plate, when fixing is by stirrups
**N Max. distance between door inside and inner plate, when fixing is by slides



MODULAR CABINET FOR DISCONNECTOR LOCK - MC.200F

Modular cabinets series MC can be ordered, up to width 1200, with a partial front door and a bolted front panel w200 mm, fixed with screws, with off-centre fixed upright. This version is suitable when a disconnecter block has to be installed. The bolted front panel is pre-drilled

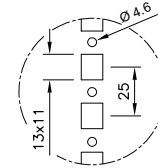
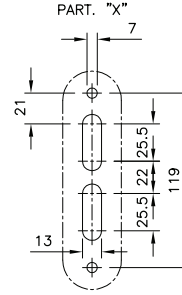
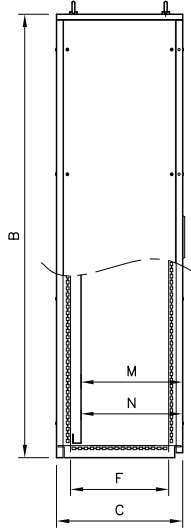
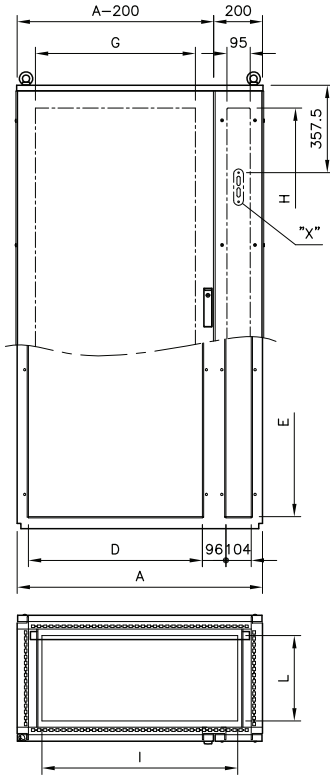

Tested by
KEMA Quality Italy

IP66

EN 60 529



TYPE NEMA 4X, 4, 12, 1

Standard UL508A - UL50
Standard 250



EN 60204-1
89/392/EEC

CABINET												OPTIONALS				
ITEM.	A	B	C	Frame inner size			Door useful size		Cable entry		M**	N**	INNER PLATES			SIDE PANELS
				D	E	F	G	H	I	L			ITEM.*	X	Y	
MC0685.200F	605	1815	515	312	1712	402	255	1630	400	350	456	420	PA0517	497	1692	MC85
MC0686.200F	605	1815	615	312	1712	502	255	1630	400	450	556	520	PA0517	497	1692	MC86
MC0688.200F	605	1815	815	312	1712	702	255	1630	400	650	756	720	PA0517	497	1692	MC88
MC0885.200F	805	1815	515	512	1712	402	455	1630	600	350	456	420	PA0717	697	1692	MC85
MC0886.200F	805	1815	615	512	1712	502	455	1630	600	450	556	520	PA0717	697	1692	MC86
MC0888.200F	805	1815	815	512	1712	702	455	1630	600	650	756	720	PA0717	697	1692	MC88
MC1085.200F	1005	1815	515	712	1712	402	655	1630	800	350	456	420	PA0917	897	1692	MC85
MC1086.200F	1005	1815	615	712	1712	502	655	1630	800	450	556	520	PA0917	897	1692	MC86
MC1088.200F	1005	1815	815	712	1712	702	655	1630	800	650	756	720	PA0917	897	1692	MC88
MC1285.200F	1208	1815	515	915	1712	402	855	1630	1004	350	456	420	PA1117	1100	1692	MC85
MC1286.200F	1208	1815	615	915	1712	502	855	1630	1004	450	556	520	PA1117	1100	1692	MC86
MC1288.200F	1208	1815	815	915	1712	702	855	1630	1004	650	756	720	PA1117	1100	1692	MC88
MC0605.200F	605	2015	515	312	1912	402	255	1830	400	350	456	420	PA0519	497	1892	MC05
MC0606.200F	605	2015	615	312	1912	502	255	1830	400	450	556	520	PA0519	497	1892	MC06
MC0608.200F	605	2015	815	312	1912	702	255	1830	400	650	756	720	PA0519	497	1892	MC08
MC0805.200F	805	2015	515	512	1912	402	455	1830	600	350	456	420	PA0719	697	1892	MC05
MC0806.200F	805	2015	615	512	1912	502	455	1830	600	450	556	520	PA0719	697	1892	MC06
MC0808.200F	805	2015	815	512	1912	702	455	1830	600	650	756	720	PA0719	697	1892	MC08
MC1005.200F	1005	2015	515	712	1912	402	655	1830	800	350	456	420	PA0919	897	1892	MC05
MC1006.200F	1005	2015	615	712	1912	502	655	1830	800	450	556	520	PA0919	897	1892	MC06
MC1008.200F	1005	2015	815	712	1912	702	655	1830	800	650	756	720	PA0919	897	1892	MC08
MC1205.200F	1208	2015	515	915	1912	402	855	1830	1004	350	456	420	PA1119	1100	1892	MC05
MC1206.200F	1208	2015	615	915	1912	502	855	1830	1004	450	556	520	PA1119	1100	1892	MC06
MC1208.200F	1208	2015	815	915	1912	702	855	1830	1004	650	756	720	PA1119	1100	1892	MC08

REMARK: Total width side panels included: dim: "A" + 9 mm

**M Max. distance between door inside and inner plate, when fixing is by stirrups
**N Max. distance between door inside and inner plate, when fixing is by slide
Cabinets W 1200 can be certified NEMA12



PAIR OF SIDE PANELS

Made of stainless steel EN 1.4301 (AISI 304) s/s finely satin-finished and protected, thickn. 15/10, for direct installation outside the module or for the multi-module unit, securing them to the frame from the outside by means of no. 8 caphead s/s screws.

ITEM.	DIMENSIONS		FOR CABINETS				
	L	H					
MC85	460	1790	MC-MCV0685	MC-MCV0885	MC-MCV1085	MC-MCV1285	MC-MCV1685
MC86	560	1790	MC-MCV0686	MC-MCV0886	MC-MCV1086	MC-MCV1286	MC-MCV1686
MC88	760	1790	MC-MCV0688	MC-MCV0888	MC-MCV1088	MC-MCV1288	MC-MCV1688
MC05	460	1990	MC-MCV0605	MC-MCV0805	MC-MCV1005	MC-MCV1205	MC-MCV1605
MC06	560	1990	MC-MCV0606	MC-MCV0806	MC-MCV1006	MC-MCV1206	MC-MCV1606
MC08	760	1990	MC-MCV0608	MC-MCV0808	MC-MCV1008	MC-MCV1208	MC-MCV1608



SAFETY BRACKETS FOR INNER PLATE

Kit consisting of no. 4 shaped squares (2 upper and 2 lower ones), working as safety lock to prevent the stresses arising in transit from releasing the plate from its rest. They permit quick coupling of the plate and keeping it in vertical position, to prevent tilting during assembling.

- **MKS** - 1 kit of squares

REMARK: not usable with slides



MODULE COUPLING KIT

Essential to couple several modules in a battery, it includes the pre-cut basket obtained from closet cell foamed material, the screws and the special nuts for easy assembling.

- **MK18** - for cabinets H 1.800
- **MK20** - for cabinets H 2.000



STIFFENING KIT

It consists of no. 4 s/s angle bars, obtained by s/s sheet shaping, with the relevant bolts and screws. For application inside the frame, close to the uprights of two coupled frames for improved stiffness and sturdiness of the structure. Their use is always recommended, particularly when batteries of several pre-assembled and coupled modules are to be transported, and/or when the weight contained in the modules exceeds 200 kg.

- **MKI** - stiffening kit



BACK DOORS

Made of AISI 304 stainless steel, thickness 20/10, finely satin-finished and protected, they feature alike the front doors and can be assembled, on request, in replacement of the bolted back panels included in the standard version.

ITEM.	PIECES	FOR CABINETS
PP0618	1	MC-MCV0685-MC-MCV0686-MC-MCV0688
PP0818	1	MC-MCV0885-MC-MCV0886-MC-MCV0888
PP1018	1	MC-MCV1085-MC-MCV1086-MC-MCV1088
PP1218	1+1	MC-MCV1285-MC-MCV1286-MC-MCV1288
PP1618	2	MC-MCV1685-MC-MCV1686-MC-MCV1688
PP0620	1	MC-MCV0605-MC-MCV0606-MC-MCV0608
PP0820	1	MC-MCV0805-MC-MCV0806-MC-MCV0808
PP1020	1	MC-MCV1005-MC-MCV1006-MC-MCV1008
PP1220	1+1	MC-MCV1205-MC-MCV1206-MC-MCV1208
PP1620	2	MC-MCV1605-MC-MCV1606-MC-MCV1608



PARTITION BAFFLES

Panel made of sendzimir sheet EN 10142 thickness 25/10, for installation between two modules to maintain a gap between them. Available in two versions: protection degree IP20 and protection degree IP65; on request it can be drilled to allow cable passage between two modules and for the connectors.

REMARK: the partition baffle excludes the use of the plate in-between

ITEM.	PROTECTION DEGREE	FOR CABINETS
ST285	IP20	MC-MCV0685 MC-MCV0885 MC-MCV1085 MC-MCV1285 MC-MCV1685
ST286	IP20	MC-MCV0686 MC-MCV0886 MC-MCV1086 MC-MCV1286 MC-MCV1686
ST288	IP20	MC-MCV0688 MC-MCV0888 MC-MCV1088 MC-MCV1288 MC-MCV1688
ST205	IP20	MC-MCV0605 MC-MCV0805 MC-MCV1005 MC-MCV1205 MC-MCV1605
ST206	IP20	MC-MCV0606 MC-MCV0806 MC-MCV1006 MC-MCV1206 MC-MCV1606
ST208	IP20	MC-MCV0608 MC-MCV0808 MC-MCV1008 MC-MCV1208 MC-MCV1608
ST685	IP65	MC-MCV0685 MC-MCV0885 MC-MCV1085 MC-MCV1285 MC-MCV1685
ST686	IP65	MC-MCV0686 MC-MCV0886 MC-MCV1086 MC-MCV1286 MC-MCV1686
ST688	IP65	MC-MCV0688 MC-MCV0888 MC-MCV1088 MC-MCV1288 MC-MCV1688
ST605	IP65	MC-MCV0605 MC-MCV0805 MC-MCV1005 MC-MCV1205 MC-MCV1605
ST606	IP65	MC-MCV0606 MC-MCV0806 MC-MCV1006 MC-MCV1206 MC-MCV1606
ST608	IP65	MC-MCV0608 MC-MCV0808 MC-MCV1008 MC-MCV1208 MC-MCV1608



SECTION BARS SYSTEM

used to make, easily and quickly, bearing structures for equipment and instruments accommodated inside the control board; pre-drilled with 25 mm pitch.



DEPTH CROSSPIECES WITH FRONT FIXING :

Section 23x50mm.

Available for all depth of cabinets, they are delivered complete with screws and fixing stirrup. Can be used to secure cables, fix bars or as bridging connection between front and rear uprights.

Ideal to secure and adjust the depth of DIN supports.

- **PRF255** - for depth. 500 - couple
- **PRF256** - for depth. 600 - couple
- **PRF258** - for depth. 800 - couple

REMARK: essential for "UL" certification

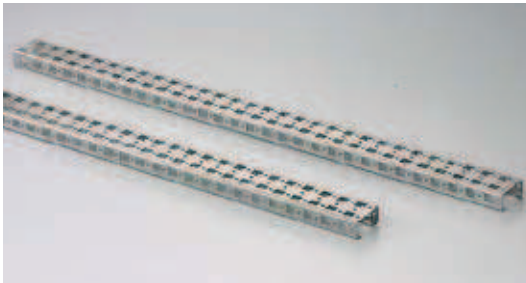

STRUCTURAL SECTION 50x25 BY THE METER

Available in 2m bars cut to size to make sturdy crosspieces or posts. A special stirrup must be requested to fix it. (code SRPF50)

- **PRF502M** - 2m bar



STIRRUP FOR STRUCTURAL SECTIONS 50x25

Square to secure the sections previously cut to size. Shape and sizes have been designed so that the holes next to the uprights can be used.

- **SPRF50** - Pack of 10 pcs.

accessories for cabinets



OVER-DOOR PANELS
pag. 47



INNER DOORS
pag. 52

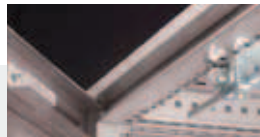

WORK PLANES
pag. 53



WORK TABLETOPS
pag. 55



INNER PLATES PA TYPE
pag. 48



INNER PLATES PS TYPE
pag. 48

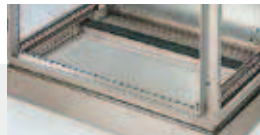

VERTICAL SLASH TYPE CLOSURE PLATES
pag. 53



ECROUS A CAGE
pag. 51



INTERMEDIATE PLATE
pag. 49

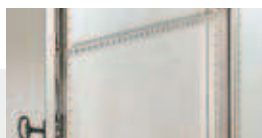

DOOR CROSSPIECES
pag. 54



BEARING SECTION BARS
pag. 49



HOISTING EYEBOLTS
pag. 54



PANELS
pag. 55



SKIRTING
pag. 50



SYSTEMS FOR MODULAR SWITCHES
pag. 56



5,5 SELF-TAPPING SCREWS
pag. 51



LOCKING-PROOF DEVICE
pag. 59



FOOT SAFETY DEVICE
pag. 60



WHEELS
pag. 60



HOISTING RODS
pag. 51



SLIDE BARS
pag. 54



HOISTING STIRRUPS
pag. 51



LAMPE
pag. 61



DIAGRAM POCKETS
pag. 59



SUPPORTS WITH DIN BARS
pag. 57 old.



LOCKS
pag. 58



TAPS
pag. 60



ADJUSTABLE FEET
pag. 49



FIXED LECTERNS
pag. 59



ELECTROCONDUCTIVE GASKET
pag. 61

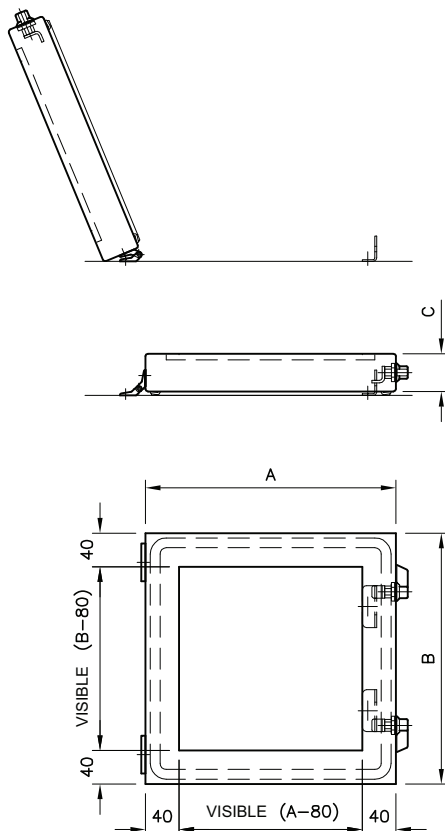

OVERDOORS

Realized in stainless steel X5 CrNi 18/10 EN 1.4301 (AISI 304) finely satin-finished, with 3+3 layer shatterproof glass, are suitable when instrumentations applied on the external door have to be protected. Complete with wing-nut lock, galvanized, black, with Yale type key and build-in seal, 180° opening. Protection degree IP65.

REMARK: when set on width exceeding the width of the over-door panel, the max. opening is 90°.

ITEM.	A	B	C
SV33/45	300	300	45
SV34/45	300	450	45
SV36/45	300	600	45
SV43/45	450	300	45
SV44/45	450	450	45
SV46/45	450	600	45
SV64/45	600	450	45
SV66/45	600	600	45
SV67/45	600	750	45
SV68/45	600	800	45
SV69/45	600	900	45
SV612/45	600	1200	45
SV77/45	750	750	45
SV710/45	750	1000	45
SV86/45	800	600	45
SV812/45	800	1200	45
SV106/45	1000	750	45

ITEM.	A	B	C
SV33/75	300	300	75
SV34/75	300	450	75
SV36/75	300	600	75
SV43/75	450	300	75
SV44/75	450	450	75
SV46/75	450	600	75
SV64/75	600	450	75
SV66/75	600	600	75
SV67/75	600	750	75
SV68/75	600	800	75
SV69/75	600	900	75
SV612/75	600	1200	75
SV77/75	750	750	75
SV710/75	750	1000	75
SV86/75	800	600	75
SV812/75	800	1200	75
SV106/75	1000	750	75

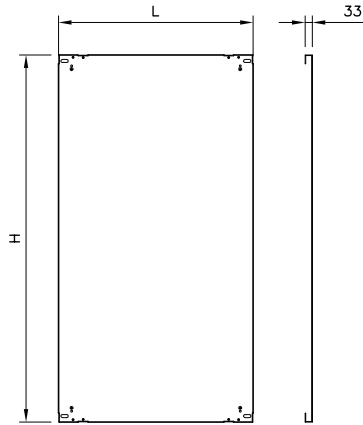

INNER PLATE TYPE PA

Realized in galvanized sheet sendzimir EN 10142 , bent on all sides for maximum stiffness; supplied in assembling kit, adjustable over the whole depth of the cabinet.

ITEM.	SIZES		FOR CABINETS SERIE MC-CX-CC	
	X	Y		
PA0517	497	1692	L.600	H.1800
PA0717	697	1692	L.800	H.1800
PA1115	1100	1492	L.1200	H.1600
PA1117	1100	1692	L.1200	H.1800
PA1515	1500	1492	L.1600	H.1600
PA1517	1505	1692	L.1600	H.1800
PA0519	497	1892	L.600	H.2000
PA0719	697	1892	L.800	H.2000
PA0919	897	1892	L.1000	H.2000
PA1119	1100	1892	L.1200	H.2000
PA1519	1505	1892	L.1600	H.2000

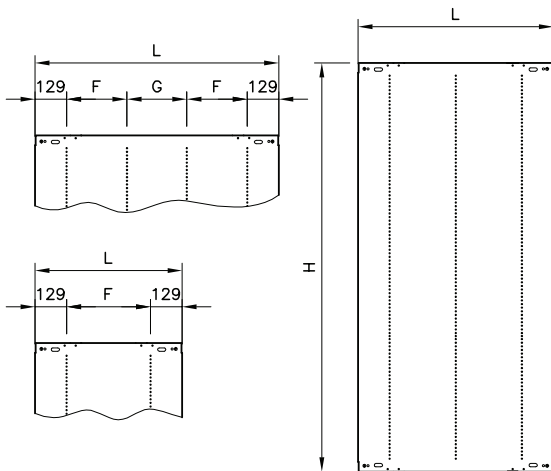

INNER PLATES TYPE PS

Realized in galvanized sheet sendzimir EN 10142, designed to allow the use of all the cabinet width. The use of these plates set in battery does not require an intermediate place since they can be connected directly one to the other.

REMARK: 2 plates PS0817 or PS0819 are required depending on the height are required for cabinets L.1600.

ITEM.	L	H	F	G	FOR CABINET
PS0617	608	1692	350	/	MC0685 - MC0686 - MC0688 - CX0685 - CX0686
PS0619	608	1892	350	/	MC0605 - MC0606 - MC0608 - CX0605 - CX0606
PS0817	808	1692	275	/	MC0885 - MC0886 - MC0888 - CX0885 - CX0886
PS0819	808	1892	275	/	MC0805 - MC0806 - MC0808 - CX0805 - CX0806
PS1017	1008	1692	250	250	MC1085 - MC1086 - MC1088 - CX1085 - CX1086
PS1019	1008	1892	250	250	MC1005 - MC1006 - MC1008 - CX1005 - CX1006
PS1217	1211	1692	325	300	MC1285 - MC1286 - MC1288 - CX1285 - CX1286
PS1219	1211	1892	325	300	MC1205 - MC1206 - MC1208 - CX1205 - CX1206



INTERMEDIATE PLATE

Designed to be assembled and disassembled even with pre-assembled and wired inner plates. Made of sendzimir EN 10142, it comes complete with all assembling accessories, in particular 2 stiffening flat bars that form with the inner plates a stiff single assembling plane. When this plate is used, it will not be possible to set the plate far back but only in front of the rear uprights.

- **PA0117** - intermediate plate for cabinets h.1800
- **PA0119** - intermediate plate for cabinets h.2000

REMARK: the intermediate plate exclude the use of the partition baffles

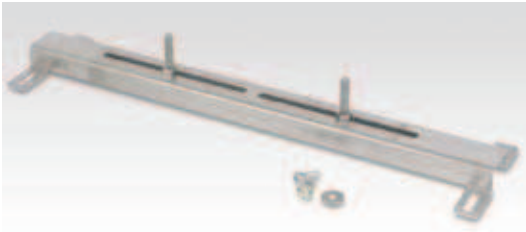

SUPPORT SECTION BARS

System of section bars, suitable to support heavy instrumentations (i.e. transformers). Supplied in assembling kit of 2 pcs, they are drilled to allow ample adjusting.

- **ST0600** - for modular cabinets MC L.600
- **ST0800** - for modular cabinets MC L.800 et L.1600 (*)
- **ST1000** - for modular cabinets MC L.1000
- **ST1200** - for modular cabinets MC L.1200

(*) **REMARK:** for cabinets MC 1600 it is necessary to require nr. 2 items ST0800. Just for MC-CX



ADJUSTABLE FEET

Cylindrical foot perfectly cleanable in AISI 304 s/s

- **SA2000**: adjustable from 125 à 165 mm
- **SA2200**: adjustable from 165 à 205 mm



SKIRTING

Simple and sturdy execution, they are made of EN 1.4301 s/s (AISI 304) carefully satin-finished and protected. Pre-arranged for side and back cable entry (or front) and for application of feet, where the need be ; the bottom is open to the ground: on request, they can be delivered with panels for bottom closing that can be used also as cable supports. Protection degree is IP20 with bottom pannel in place. Can be delivered either in assembling kit or pre-assembled, complete with the necessary kit for securing to the ground. Available in 100 and 200 mm height.

ITEM.	Height mm	For cabinets CC-CX-MC	Bottom closing panel
ZA03105	100	L.300-P.500	P0305
ZA03205	200	L.300-P.500	P0305
ZA03106	100	L.300-P.600	P0306
ZA03206	200	L.300-P.600	P0306
ZA03108	100	L.300-P.800	P0308
ZA03208	200	L.300-P.800	P0308
ZA04105	100	L.400-P.500	P0405
ZA04205	200	L.400-P.500	P0405
ZA04106	100	L.400-P.600	P0406
ZA04206	200	L.400-P.600	P0406
ZA04108	100	L.400-P.800	P0408
ZA04208	200	L.400-P.800	P0408
ZA06105	100	L.600-P.500	P0605
ZA06205	200	L.600-P.500	P0605
ZA06106	100	L.600-P.600	P0606
ZA06206	200	L.600-P.600	P0606
ZA06108	100	L.600-P.800	P0608
ZA06208	200	L.600-P.800	P0608
ZA08105	100	L.800-P.500	P0805
ZA08205	200	L.800-P.500	P0805
ZA08106	100	L.800-P.600	P0806
ZA08206	200	L.800-P.600	P0806
ZA08108	100	L.800-P.800	P0808
ZA08208	200	L.800-P.800	P0808
ZA10105	100	L.1000-P.500	P1005
ZA10205	200	L.1000-P.500	P1005
ZA10106	100	L.1000-P.600	P1006
ZA10206	200	L.1000-P.600	P1006
ZA10108	100	L.1000-P.800	P1008
ZA10208	200	L.1000-P.800	P1008
ZA12105	100	L.1200-P.500	P1205
ZA12205	200	L.1200-P.500	P1205
ZA12106	100	L.1200-P.600	P1206
ZA12206	200	L.1200-P.600	P1206
ZA12108	100	L.1200-P.800	P1208
ZA12208	200	L.1200-P.800	P1208
ZA16105	100	L.1600-P.500	P1605
ZA16205	200	L.1600-P.500	P1605
ZA16106	100	L.1600-P.600	P1606
ZA16206	200	L.1600-P.600	P1606
ZA16108	100	L.1600-P.800	P1608
ZA16208	200	L.1600-P.800	P1608

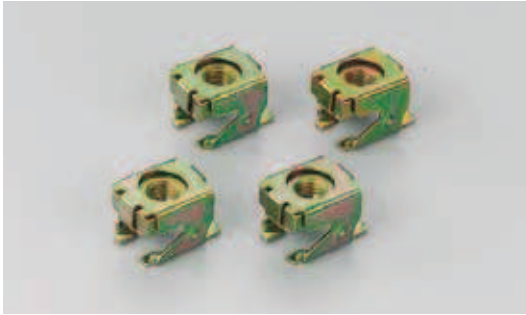

CAGE NUTS

Cage nuts for front insertion, available with threading M6 and M8, particularly sturdy and simple to install.

- **DGIFM6** - pack of 50 pcs M6
- **DGIFM8** - pack of 50 pcs M8



SELF-THREADING SCREWS 5.5

Particularly recommended to secure equipment in the drills \varnothing 4.6 arranged for the purpose on the frame and on the section bars.

- **VA05** - pack of 50 pcs

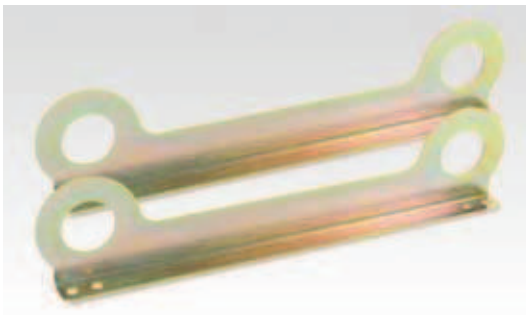

HOISTING STIRRUPS

Realized in zinc-coated sheet, they are recommended when coupled and pre-wired modules of considerable weight have to be hoisted, they can be used alone or combined with the hoisting bars and are available in kits of 2 and 3 pieces.

Max load hoisting stirrup can lift 600 Kg/m.

ITEM.	FOR CABINETS WIDTH	DEPTH	KIT
SZ025	600-800-1000-1200	500	2PZ
SZ026	600-800-1000-1200	600	2PZ
SZ028	600-800-1000-1200	800	2PZ
SZ035	1600	500	3PZ
SZ036	1600	600	3PZ
SZ038	1600	800	3PZ



HOISTING BARS

To be combined with the hoisting stirrups to handle coupled modules of fairly heavy weight. They are realized in galvanized pipe diam. 60.3. Hoisting can be done by special sliding hoisting points that permit to properly balance the weight even if unbalanced. They are supplied in pair, by the meter, complete with two hoisting points each bar.

- **BSA01**

REMARK: just for MC-CX cabinets



INNER DOORS

Manufactured in EN 1.4301 (AISI 304) s/s, finely satin-finished and protected, thickness 20/10, it is delivered in assembling kit and is used to install equipment inside the cabinets. The gap between the inner door and the door can be adjusted to two depth of 65 or 110 mm. The inner door can be right- or left-hinged. It can stand instruments up to a maximum weight of 30 Kg. Protection degree IP20 (IP54 on demand). Drillings can be made to order. For cabinets w 1200 the special upright, item kit CP1800 (for h.1800) or kit CP2000 (for h.2000) must be ordered.

SINGLE ITEM.	SIZES		FOR CABINET SERIES	
	A	B		
CP0616	490	1491	L.600	H.1600
CP0618	490	1691	L.600	H.1800
CP0620	490	1891	L.600	H.2000
CP0816	690	1691	L.800	H.1600
CP0818	690	1691	L.800	H.1800
CP0820	690	1891	L.800	H.2000
CP1018	890	1691	L.1000	H.1800
CP1020	890	1891	L.1000	H.2000

When an inner door is assembled on any cabinet L.1200 a removable central upright must always be used:

FOR CABINETS L 1200	UPRIGHT REQUIRED
MC H 1800	MMC18
MC H 2000	MMC20
CX H 1800	MCX18
CX H 2000	MCX20
CC H 1600	MCC16
CC H 1800	MCC18

Also, for cabinets series CC two uprights code MLCC16 (for H.1600) or MLCC18 (for cabinets H.1800) are required

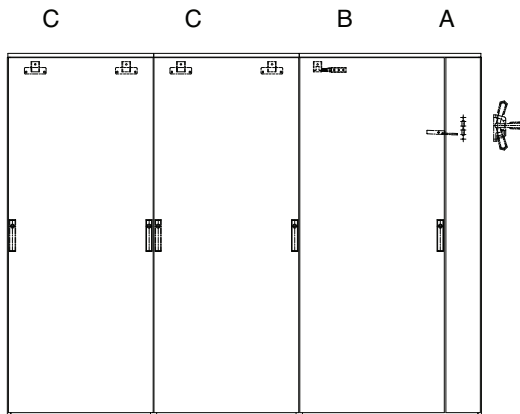

INTERLOCKS

Mechanical system that allows to establish a priority of opening of the doors for cabinets assembled in battery, it is available in three types: disconnecting switch interlock, primary interlock and secondary interlock. They have to be ordered and applied as shown on the drawing.

A) Disconnecter interlock CODE MKP.IS (Bolted panel)

B) Primary interlock CODE MKP.PR (Door with lock on the panel side or towards the cabinet outside – interlock opposite to the lock)

C) Secondary interlock CODE MKP.SE (Door with right or left lock, at choice – interlock on the same side as the lock)

REMARK: when using on the CX series, use an additional crosspiece

- **TRS06** for L.600
- **TRS08** for L.800
- **TRS10** for L.1000
- **TRS12** for L.1200

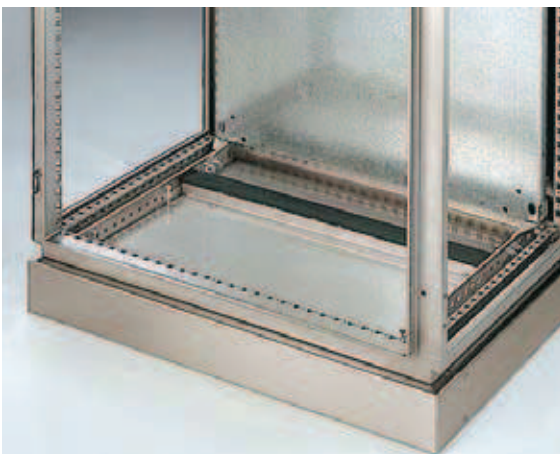
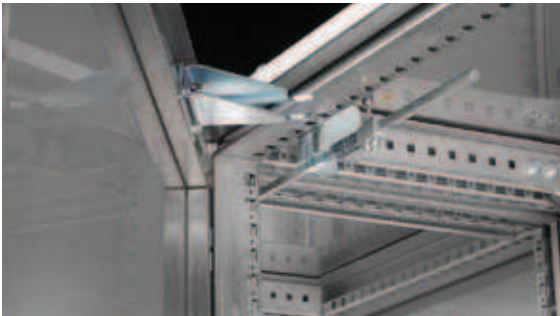

SLASH-TYPE CLOSURES

For use in place of the standard fairlead, they are highly recommended where easy cable access is desired and no special tightness is required. The skirting board is essential with this type of closure.

- **PCG0600** - for cabinets CX L.600
- **PCG0800** - for cabinets CX L.800
- **PCG1000** - for cabinets CX L.1000
- **PCG1200** - for cabinets CX L.1200

REMARK: for cabinets L.1600 no. 2 PCG0800 must be ordered



CROSS ELEMENTS FOR DOOR:

Section 20x20mm.

Available for the doors of all cabinets. Designed to be secured directly to the inner frame by self-tapping screws diam. 5.5 and by bi-adhesive tape to the door. They are the ideal fixing to secure cableways, sheaths or cables and/or to stiffen widely drilled doors

- **PRP256** - for width. 600
- **PRP258** - for width. 800
- **PRP250** - for width. 1000



HOISTING EYEBOLTS

Available both in galvanized steel and stainless steel, they are supplied in kits of 4 pieces and are recommended when single modules of limited weight have to be handled. Max hoisting load: 450 Kg for per pair of eyebolts.

- **GZ04** - Kit of no 4 eyebolts, galvanized - for cabinets L.600-800-1000-1200
- **GZ06** - Kit of no. 6 eyebolts, galvanized - for cabinets L.1600
- **G104** - Kit of no. 4 eyebolts, galvanized - for cabinets L.600-800-1000-1200
- **G106** - Kit of no. 6 eyebolts, galvanized - for cabinets L.1600



SLIDE GUIDES

Designed and manufactured to facilitate the introduction into the cabinet, through the side panel, of inner plates made of several modules, factory assembled, though of a considerable weight. The kit includes a lower guide, the sliding rollers for application to the plate, and the screws for assembling. Available in four lengths:

- **GSP06** - pair of sliding guides for cabinets L.600
- **GSP08** - pair of sliding guides for cabinets L.800
- **GSP10** - pair of sliding guides for cabinets L.1000
- **GSP12** - pair of sliding guides for cabinets L.1200

(*) **REMARK:** two slide guide GS08 are required for cabinets L.1600, only for the series MC CX

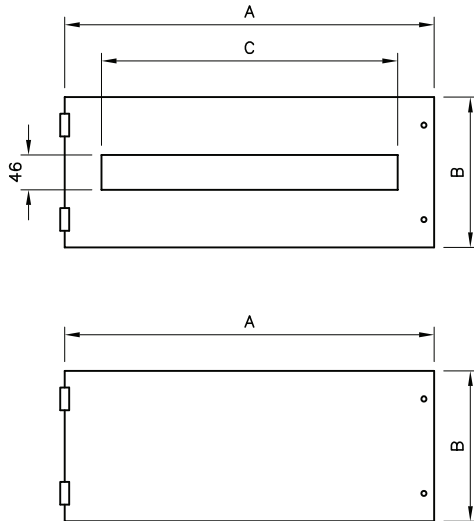

PANELS

The front panels, available in 3 heights (200, 400, and 600 mm) are hinged on one side while on the other have a screw closure. Available either drilled or solid (the latter can be drilled to drawing).

The useful compartment for panel housing is 1.600 mm. for cabinets having nominal height 1.800 mm. and 1.800 mm. for cabinet having nominal height 2.000 mm. The gap between panels and the front door can be 100 mm or 70 mm.

ITEM.	OUT. SIZES			NO. OF MODULES PER PANEL	FOR FRAMES
	A	B	C		
PMF0620	480	200	396	22	TM-TC L.600
PMF0640	480	400	396	22	TM-TC L.600
PMF0660	480	600	396	22	TM-TC L.600
PMC0620	480	200		CIECO-BLIND	TM-TC L.600
PMC0640	480	400		CIECO-BLIND	TM-TC L.600
PMC0660	480	600		CIECO-BLIND	TM-TC L.600
PMF0820	680	200	594	33	TM-TC L.800
PMF0840	680	400	594	33	TM-TC L.800
PMF0860	680	600	594	33	TM-TC L.800
PMC0820	680	200		CIECO-BLIND	TM-TC L.800
PMC0840	680	400		CIECO-BLIND	TM-TC L.800
PMC0860	680	600		CIECO-BLIND	TM-TC L.800
PMF1020	880	200	792	44	TM-TC L.1000
PMF1040	880	400	792	44	TM-TC L.1000
PMF1060	880	600	792	44	TM-TC L.1000
PMC1020	880	200		CIECO-BLIND	TM-TC L.1000
PMC1040	880	400		CIECO-BLIND	TM-TC L.1000
PMC1040	880	600		CIECO-BLIND	TM-TC L.1000



WORK TABLETOPS

Made of AISI 304 s/s, 2B finishing; available in 3 widths and fit for being installed inside either on compact cabinets or on modular ones. To be fixed to the inner frames of the doors, they are equipped with supporting bracket

- **PL0600** for doors L.600
- **PL0800** for doors L.800
- **PL1000** for doors L.1000



IP20

SYSTEMS FOR MODULAR SWITCHES

The modular cabinets series MC/CX are particularly suitable to accommodate modular switches. This application requires the matching frame formed by 2 pre-drilled uprights with balancing panels and assembling screws.

- **TM0618:** for L. 600 H. 1800
- **TM0620:** for L. 600 H. 2000
- **TM0818:** for L. 800 H. 1800
- **TM0820:** for L. 800 H. 2000
- **TM1018:** for L. 1000 H. 1800
- **TM1020:** for L. 1000 H. 2000

When installing an inner door on any cabinet L.1200 a removable central uprights must always be used:

FOR CABINETS L 1200	UPRIGHT TO BE USED
MC H 1800	MMC18
MC H 2000	MMC20
CX H 1800	MCX18
CX H 2000	MCX20



SUPPORTS WITH DIN BARS

Delivered with drilled standard panels, can be ordered separately for the assembling of special equipment or to be accommodated behind blind panels. They come complete with a pair of sturdy rests, DIN bar and corresponding bolts and screws; all EN 1.4301 (AISI 304) s/s execution.

ITEM.	FOR COMPACT CABINET
SDM06	L 1200
SDM08	L 800 e L 1600
SDM10	L 1000

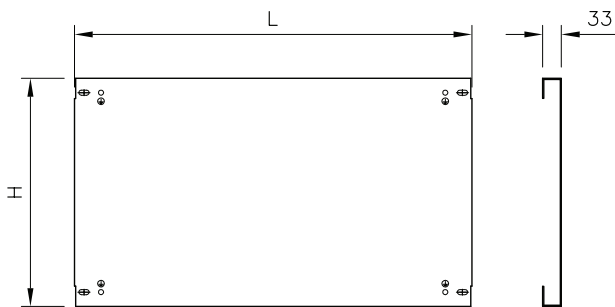

PARTIAL INNER PLATES FOR MODULAR PANELS

Partila plates for modular panels to be always combined with the plate supportingo uprights for the MC – CX series

ITEM.	X	Y	FOR PANELS CODE
PA0502	500	200	PMC0620 PMF0620
PA0504	500	400	PMC0640 PMF0640
PA0506	500	200	PMC0660 PMF0660
PA0702	700	200	PMC0820 PMF0820
PA0704	700	400	PMC0840 PMF0840
PA0706	700	600	PMC0860 PMF0860
PA0902	900	200	PMC1020 PMF1020
PA0904	900	400	PMC1040 PMF1040
PA0906	900	600	PMC1060 PMF1060

PLATE SUPPORTING UPRIGHTS

ITEM.	H
MSPA18	1800
MSPA20	2000



RATCHET LOCK

The standard outfit for all cabinets includes the ratchet lock It. SG329.
Various optional locks are however available, all perfectly interchangeable with the standard ones, either with low-voltage or Yale key.

ITEM.	TYPE	EXTERNAL	INSERT MATERIAL
SG321	“T” handle key EK333(*)	black polyamides	A.304 s/s
SG327	“L” handle key EK333(*)	black polyamides	A.304 s/s
SG328	rotating handle key EK333(*)	black polyamides	A.304 s/s
SG329(**)	box lock - twin-comb insert	black polyamides	A.304 s/s
SG330(**)	rotating handle with twin-comb insert	black polyamides	Stainless steel

REMARKS:

(*) Key EK333 - Yale type - is supplied with the lock. Different key coding can be provided on request

(**) Lock item SG215S is supplied without key. Optional key, to be ordered separately: item SG205CG - not s/s.



DIAGRAM HOLDING POCKET

Delivered in assembling kit with bi-adhesive tape, available in 3 models:

- **SG109**: orange ABS, for A4 documents
- **SG108**: AISI 304 stainless steel, for A4 documents
- **SG110**: AISI 304 stainless steel, for A3 documents



FIXED LECTERN

IP66

Made of AISI 304 s/s finely satin-finished and protected, it is fitted directly to the door. Their execution and shape enable good availability of space, even in restricted space conditions. The handy lower panel also allows wiring without the need for pushbuttons, instruments or raceways to be secured to movable or removable part. The top surface is perfectly smooth and free from gaps for improved cleaning. Three lengths are available:

- **SA531** - fixed lectern L.600
- **SA532** - fixed lectern L.800
- **SA535** - fixed lectern L.1000



ANTI-CLOSING DEVICE

Made of AISI 304 stainless steel, recommended to avoid the door accidental closing. Delivered in assembling kit.

- **DAC02**



SET OF 4 CASTERS DIAM. 80 WITH S/S. SUPPORT

Grey rubber wheels, two with double-action brake. Capacity 50 kg each

- **RPF080**



SET OF FOOT GUARDS FOR WHEELS Ø 80

Set of 4 safety guards made of S.S. for application to wheels, to prevent accidental foot crushing.

- **SP080**



TAPS



The taps, without lamp, available in various versions, are to be fixed on 35mm DIN rail (to be ordered separately) and connected by screwless press-on terminals.

TECHNICAL DATA

- **Connexion:** 3 press-on terminals for flexible wire
- **Fixing:** Clip for assembling on 35mm DIN rail EN 50022
- **Housing:** UL94 V-0 plastic
- **Sizes:** 92 x 62 x 48 mm
- **Weight:** 0.20 Kg
- **Assembling position:** at customer's choice
- **Oper. Temp.:** -45°C +70°C
- **Protection degree:** IP20

CODES	VOLTAGE	TAP	CURRENT	APPROVAL
PSFD	250V AC	GERMANY	16.0 A	
PSFF	250V AC	FRANCE	16.0 A	
PSFCH	250V AC	SWITZERLAND	10.0 A	
PSFGB	250V AC	GREAT BRITAIN/ IRELAND	13.0 A	
PSFUS	125V AC	USA/CANADA	15.0 A	c RU us
PSFI	250V AC	ITALY	16.0 A	



LAMP

For use in control board featuring limited dimensions and high density of components, they are delivered complete with fixing stirrups and screws for easy installation anywhere inside the cabinet.

Available either without tap or with several types of taps.

TECHNICAL DATA

- **Absorbed power:** 11 W (incandescent lamp 75W)
- **Lighting power:** 900 Lm
- **Bulb:** energy-saving bulb, bulb socket 2G7 10.000 h
- **Switch:** ON/OFF switch for lighting lamps (PIR motion detector on request)
- Terminal 2,5 mm² with traction-proof device
- Max. torque 0,8 Nm
- **Fixing:** by screw, M5, distance 300 mm
- **Housing:** light grey UL94 V-D plastic
- **Sizes:** 345 x 91 x 40 mm
- **Installation:** narrow side / large side
- **Temp. Of work envir.:** -20°C +50°C (-4°F +122°F)
- Protection degree: IP20

CODES	VOLTAGE	TAP	CURRENT	APPROVAL
LP230D	230V AC 50/60 HZ	GERMANY	16.0 A	VDE
LP230F	230V AC 50/60 HZ	FRANCE	16.0 A	VDE
LP230CH	230V AC 50/60 HZ	SWITZERLAND	10.0 A	VDE
LP230GB	230V AC 50/60 HZ	GREAT BRITAIN/ IRELAND	13.0 A	VDE
LP120US	120V AC 50/60 HZ	USA/CANADA	15.0 A	c RU us
LP230	230V AC 50/60 HZ	NONE		VDE + c RU us
LP120	120V AC 50/60 HZ	NONE		c RU us

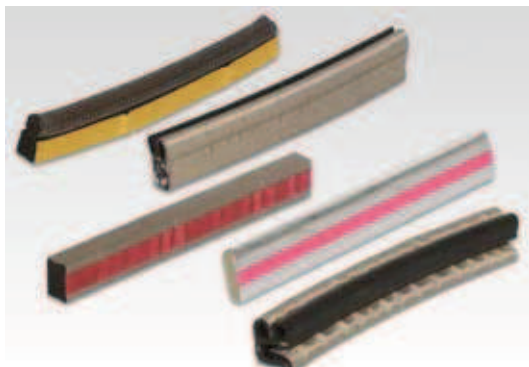

GARNITURE ELECTROCONDUCTRICE

La garniture électroconductrice est nécessaire pour le blindage du champ électrique ou magnétique.

L'élasticité de la garniture est obtenue par l'emploi de mousses de matériaux divers: silicones, néoprènes ou epdm selon les conditions d'emploi.

- GCE